

**PNP Silicon AF Transistors**

- For AF driver and output stages
- High collector current
- Low collector-emitter saturation voltage
- Complementary types: BCP54 ... BCP56 (NPN)
- Pb-free (RoHS compliant) package <sup>1)</sup>
- Qualified according AEC Q101

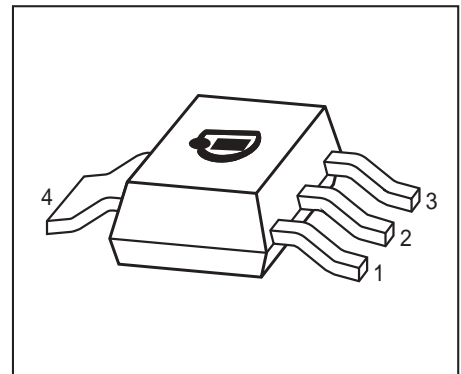

| Type     | Marking | Pin Configuration |     |     |     |   |   | Package |
|----------|---------|-------------------|-----|-----|-----|---|---|---------|
| BCP51    | *       | 1=B               | 2=C | 3=E | 4=C | - | - | SOT223  |
| BCP51-16 | *       | 1=B               | 2=C | 3=E | 4=C | - | - | SOT223  |
| BCP52-16 | *       | 1=B               | 2=C | 3=E | 4=C | - | - | SOT223  |
| BCP53-10 | *       | 1=B               | 2=C | 3=E | 4=C | - | - | SOT223  |
| BCP53-16 | *       | 1=B               | 2=C | 3=E | 4=C | - | - | SOT223  |

\* Marking is the same as type-name

<sup>1)</sup>Pb-containing package may be available upon special request

**Maximum Ratings**

| Parameter                                                | Symbol    | Value       | Unit             |
|----------------------------------------------------------|-----------|-------------|------------------|
| Collector-emitter voltage                                | $V_{CEO}$ |             | V                |
| BCP51                                                    |           | 45          |                  |
| BCP52                                                    |           | 60          |                  |
| BCP53                                                    |           | 80          |                  |
| Collector-emitter voltage                                | $V_{CER}$ |             |                  |
| BCP51                                                    |           | 45          |                  |
| BCP52                                                    |           | 60          |                  |
| BCP53                                                    |           | 100         |                  |
| Collector-base voltage                                   | $V_{CBO}$ |             |                  |
| BCP51                                                    |           | 45          |                  |
| BCP52                                                    |           | 60          |                  |
| BCP53                                                    |           | 100         |                  |
| Emitter-base voltage                                     | $V_{EBO}$ | 5           |                  |
| Collector current                                        | $I_C$     | 1           | A                |
| Peak collector current                                   | $I_{CM}$  | 1.5         |                  |
| Base current                                             | $I_B$     | 100         | mA               |
| Peak base current                                        | $I_{BM}$  | 200         |                  |
| Total power dissipation-<br>$T_S \leq 124^\circ\text{C}$ | $P_{tot}$ | 1.5         | W                |
| Junction temperature                                     | $T_j$     | 150         | $^\circ\text{C}$ |
| Storage temperature                                      | $T_{stg}$ | -65 ... 150 |                  |

**Thermal Resistance**

| Parameter                                | Symbol     | Value     | Unit |
|------------------------------------------|------------|-----------|------|
| Junction - soldering point <sup>1)</sup> | $R_{thJS}$ | $\leq 17$ | K/W  |

<sup>1)</sup>For calculation of  $R_{thJA}$  please refer to Application Note Thermal Resistance

**Electrical Characteristics** at  $T_A = 25^\circ\text{C}$ , unless otherwise specified

| Parameter                                                                                                                                                                                                                                                                                                                 | Symbol        | Values                      |                           |                             | Unit          |
|---------------------------------------------------------------------------------------------------------------------------------------------------------------------------------------------------------------------------------------------------------------------------------------------------------------------------|---------------|-----------------------------|---------------------------|-----------------------------|---------------|
|                                                                                                                                                                                                                                                                                                                           |               | min.                        | typ.                      | max.                        |               |
| <b>DC Characteristics</b>                                                                                                                                                                                                                                                                                                 |               |                             |                           |                             |               |
| Collector-emitter breakdown voltage<br>$I_C = 10\text{ mA}$ , $I_B = 0$ , BCP51<br>$I_C = 10\text{ mA}$ , $I_B = 0$ , BCP52<br>$I_C = 10\text{ mA}$ , $I_B = 0$ , BCP53                                                                                                                                                   | $V_{(BR)CEO}$ | 45<br>60<br>80              | -<br>-<br>-               | -<br>-<br>-                 | V             |
| Collector-base breakdown voltage<br>$I_C = 100\ \mu\text{A}$ , $I_E = 0$ , BCP51<br>$I_C = 100\ \mu\text{A}$ , $I_E = 0$ , BCP52<br>$I_C = 100\ \mu\text{A}$ , $I_E = 0$ , BCP53                                                                                                                                          | $V_{(BR)CBO}$ | 45<br>60<br>100             | -<br>-<br>-               | -<br>-<br>-                 |               |
| Emitter-base breakdown voltage<br>$I_E = 10\ \mu\text{A}$ , $I_C = 0$                                                                                                                                                                                                                                                     | $V_{(BR)EBO}$ | 5                           | -                         | -                           |               |
| Collector-base cutoff current<br>$V_{CB} = 30\text{ V}$ , $I_E = 0$<br>$V_{CB} = 30\text{ V}$ , $I_E = 0$ , $T_A = 150\ ^\circ\text{C}$                                                                                                                                                                                   | $I_{CBO}$     | -<br>-                      | -<br>-                    | 0.1<br>20                   | $\mu\text{A}$ |
| DC current gain <sup>1)</sup><br>$I_C = 5\text{ mA}$ , $V_{CE} = 2\text{ V}$<br>$I_C = 150\text{ mA}$ , $V_{CE} = 2\text{ V}$ , BCP51<br>$I_C = 150\text{ mA}$ , $V_{CE} = 2\text{ V}$ , BCP53-10<br>$I_C = 150\text{ mA}$ , $V_{CE} = 2\text{ V}$ , BCP51-16...BCP53-16<br>$I_C = 500\text{ mA}$ , $V_{CE} = 2\text{ V}$ | $h_{FE}$      | 25<br>40<br>63<br>100<br>25 | -<br>-<br>100<br>160<br>- | -<br>250<br>160<br>250<br>- | -             |
| Collector-emitter saturation voltage <sup>1)</sup><br>$I_C = 500\text{ mA}$ , $I_B = 50\text{ mA}$                                                                                                                                                                                                                        | $V_{CEsat}$   | -                           | -                         | 0.5                         | V             |
| Base-emitter voltage <sup>1)</sup><br>$I_C = 500\text{ mA}$ , $V_{CE} = 2\text{ V}$                                                                                                                                                                                                                                       | $V_{BE(ON)}$  | -                           | -                         | 1                           |               |
| <b>AC Characteristics</b>                                                                                                                                                                                                                                                                                                 |               |                             |                           |                             |               |
| Transition frequency<br>$I_C = 50\text{ mA}$ , $V_{CE} = 10\text{ V}$ , $f = 100\text{ MHz}$                                                                                                                                                                                                                              | $f_T$         | -                           | 125                       | -                           | MHz           |

<sup>1)</sup>Pulse test:  $t < 300\ \mu\text{s}$ ;  $D < 2\%$

**DC current gain  $h_{FE} = f(I_C)$**

$V_{CE} = 2\text{ V}$

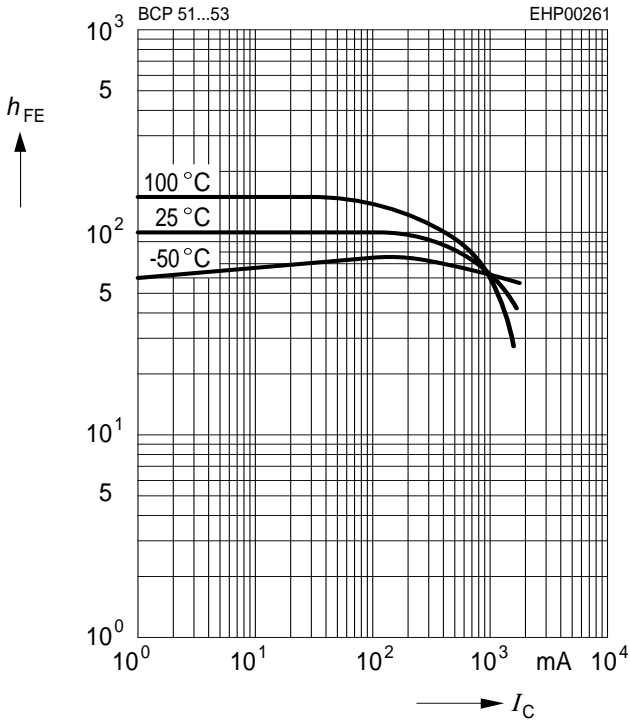

**Collector-emitter saturation voltage**

$I_C = f(V_{CEsat}), h_{FE} = 10$

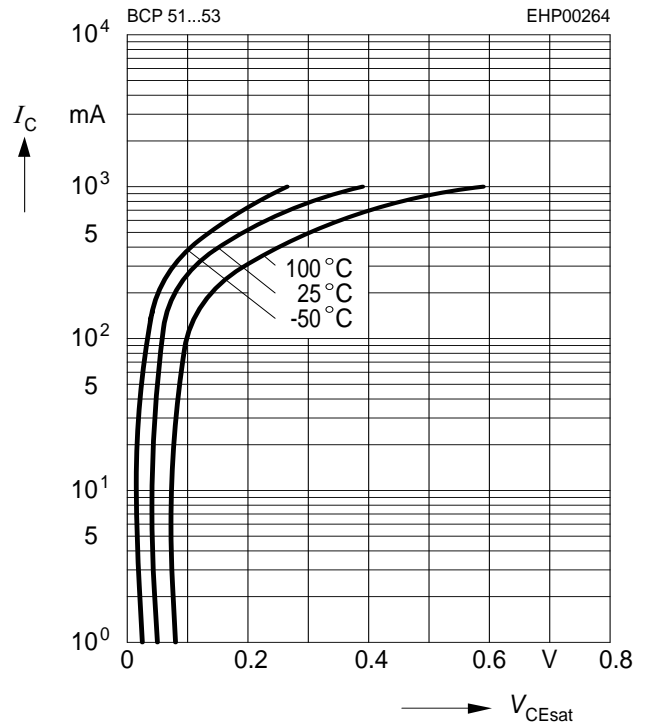

**Base-emitter saturation voltage**

$I_C = f(V_{BEsat}), h_{FE} = 10$

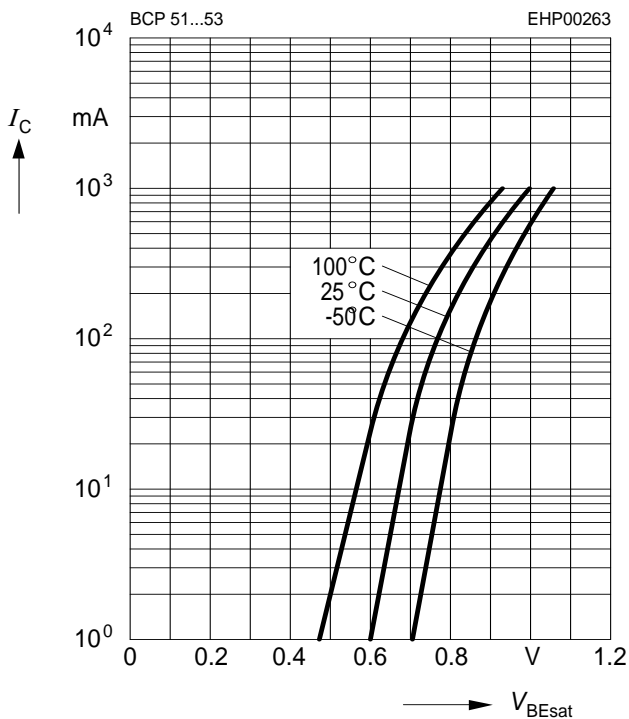

**Collector cutoff current  $I_{CBO} = f(T_A)$**

$V_{CBO} = 30\text{ V}$

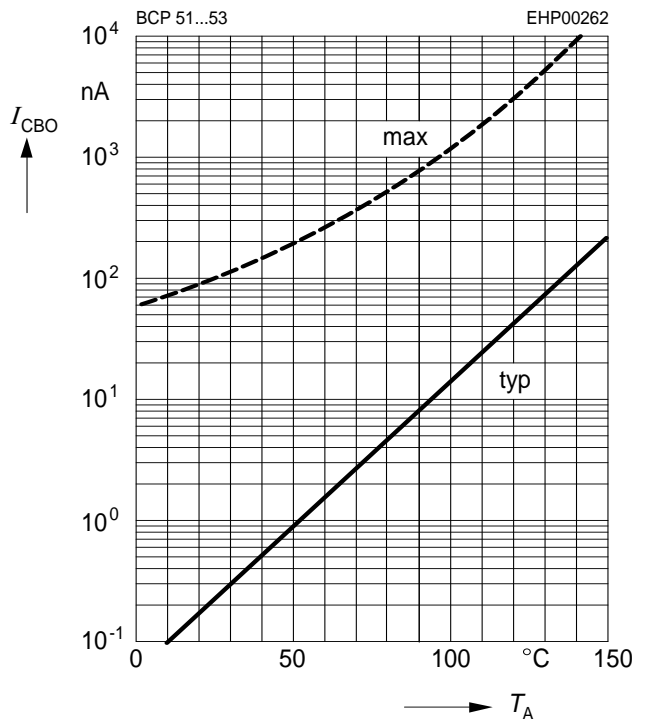

**Transition frequency  $f_T = f(I_C)$**

$V_{CE} = 10\text{ V}$

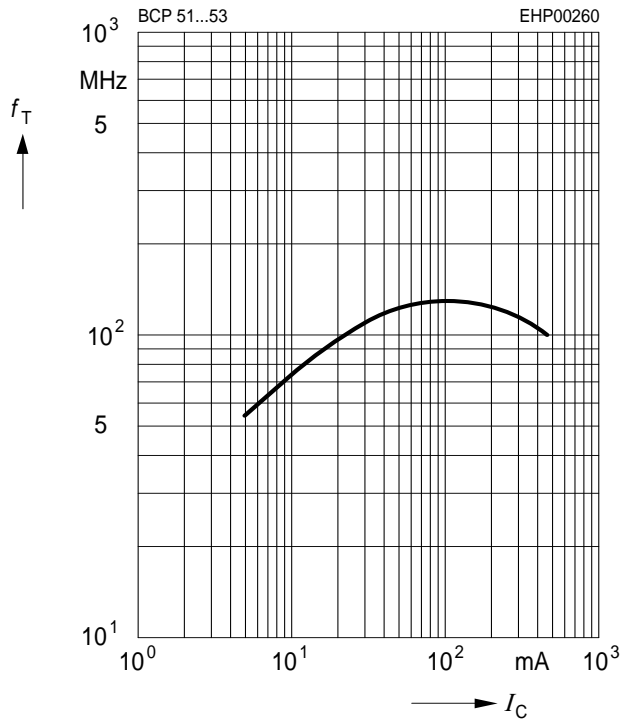

**Total power dissipation  $P_{tot} = f(T_S)$**

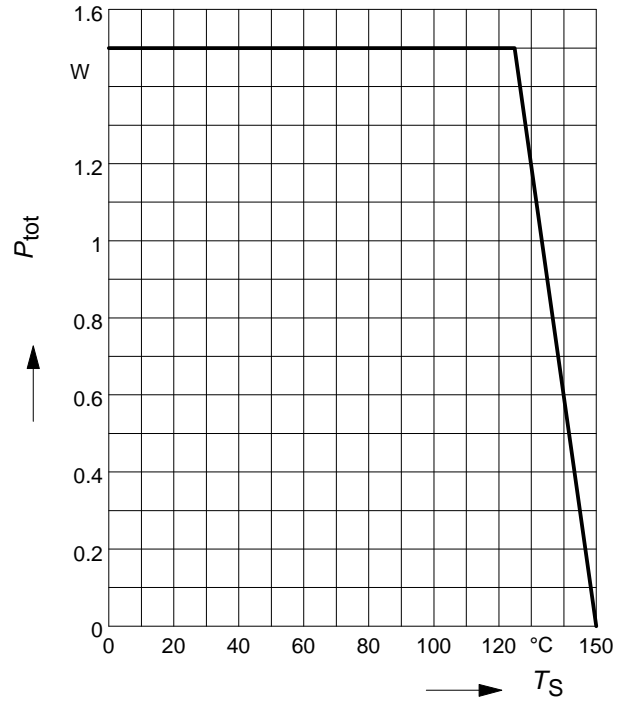

**Permissible Pulse Load**

$P_{totmax}/P_{totDC} = f(t_p)$

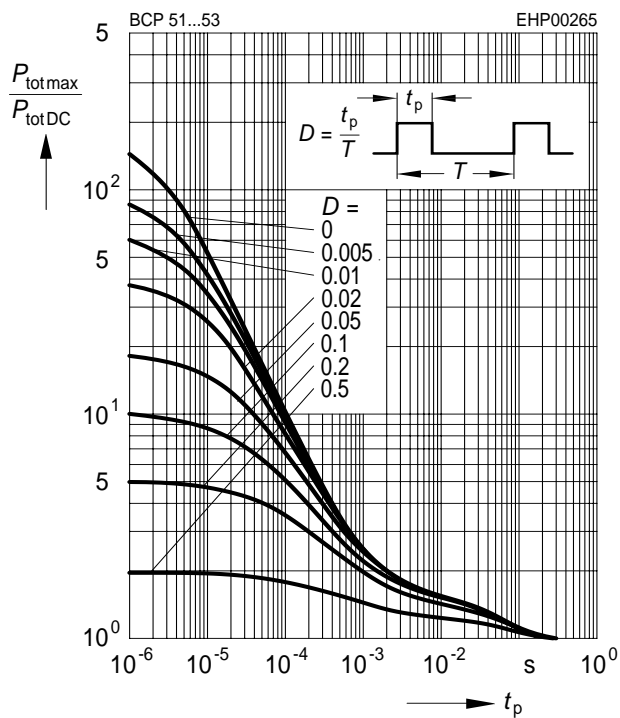

Package Outline

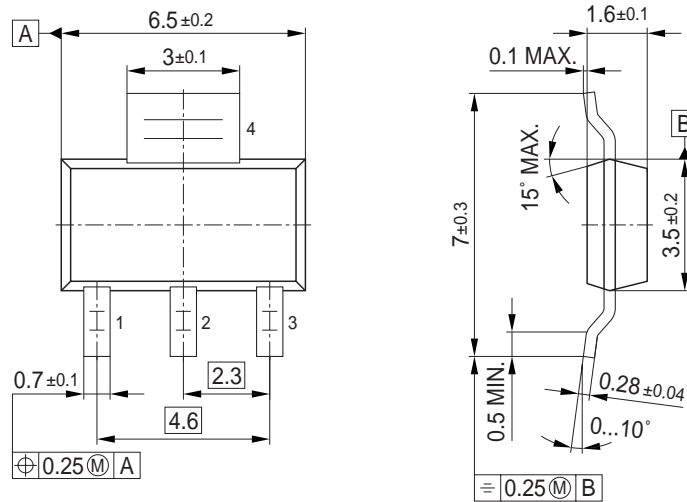

Foot Print

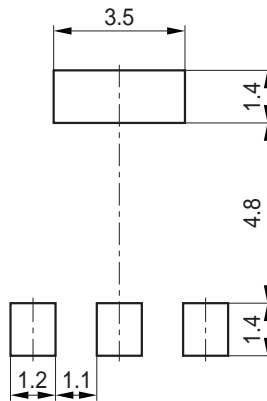

Marking Layout (Example)

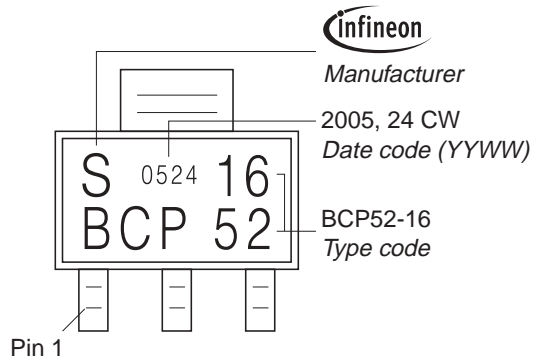

Packing

Reel  $\varnothing 180$  mm = 1.000 Pieces/Reel  
 Reel  $\varnothing 330$  mm = 4.000 Pieces/Reel

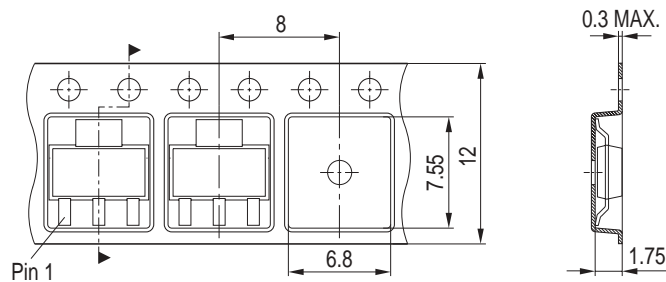

Edition 2006-02-01  
Published by  
Infineon Technologies AG  
81726 München, Germany  
© Infineon Technologies AG 2007.  
All Rights Reserved.

### **Attention please!**

The information given in this dokument shall in no event be regarded as a guarantee of conditions or characteristics ("Beschaffenheitsgarantie"). With respect to any examples or hints given herein, any typical values stated herein and/or any information regarding the application of the device, Infineon Technologies hereby disclaims any and all warranties and liabilities of any kind, including without limitation warranties of non-infringement of intellectual property rights of any third party.

### **Information**

For further information on technology, delivery terms and conditions and prices please contact your nearest Infineon Technologies Office ([www.infineon.com](http://www.infineon.com)).

### **Warnings**

Due to technical requirements components may contain dangerous substances. For information on the types in question please contact your nearest Infineon Technologies Office.

Infineon Technologies Components may only be used in life-support devices or systems with the express written approval of Infineon Technologies, if a failure of such components can reasonably be expected to cause the failure of that life-support device or system, or to affect the safety or effectiveness of that device or system.

Life support devices or systems are intended to be implanted in the human body, or to support and/or maintain and sustain and/or protect human life. If they fail, it is reasonable to assume that the health of the user or other persons may be endangered.